

DX ISOMAX Series

The ISOMAX range of directional control valves complies with ISO 15407-1 and VDMA 24563 for sizes 02 and 01 and ISO 5599-1 for sizes 1, 2 and 3. ISOMAX provides flows from 0.55 Cv to 4.15 Cv.

The ISOMAX range includes valves for pneumatic and electrical actuation with a wide choice of subbases and manifolds to suit different application needs.

All ISOMAX products use high-tech ceramic switching technology providing:

Excellent reliability

- Long life in excess of 100 million operations*
- Operates with lubricated or non-lubricated air
- Low sensitivity to air quality changes

High performance

- Slide valve concept allows high flow / size ratio and short response time due to short slide stroke and low friction

Stable long lasting performances

- Low friction switching: minimum wear of the valve member / seal assembly

Valves fitted with switchable selector to give internal or external pilot supply

Corrosion free and modern design

Vacuum operation

Dual pressure

* Refer to our warranty conditions.

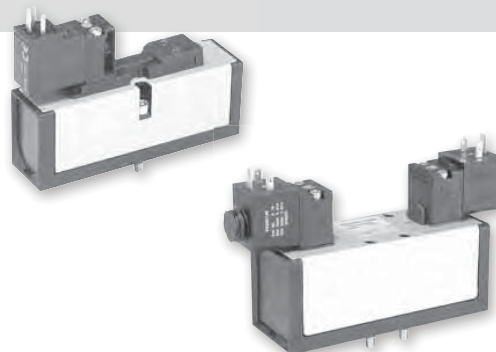

Operating information

Operating Pressure: Vacuum to 145 PSIG (10 bar)

Function		M.O.P (PSIG)
20, 21, 22, 23	2-position, spring return	36
50, 51, 53, 54	2-position, air return	30
04, 05, 06, 08	2-position	15
09, 11, 12, 27	3-position, CE	45
16, 18, 19, 25	3-position, APB	45

Working temperatures: -10°C to 60°C (14°F to 140°F)

Storage temperatures: -20°C to 70°C (-4°F to 158°F)

Material specifications

Body	Polyamide reinforced fiberglass
Casing	Anodized aluminum
End plates	Painted zinc plated steel
Function selector	Polyamide reinforced fiberglass
Screws	Zinc plated steel
Seals	Nitrile
Seat	Ceramic
Springs	Stainless steel
Top cover seals	Polyester
Valve members	Self lubricating acetal
Valve plate	Zinc

Modulflex Series

Isys Micro Series

Isys ISO Series

Fieldbus





DX ISOMAX Series





Valvair II Series

D



Subbase & Manifold Valve Products

DX02 ISO Valves

Symbol	Type	Cv	Operator	Pilot	Override	24 VDC	120 VAC
	4-way, 2-position, spring return	0.55	Single solenoid	Internal	Non-locking	DX02-621-951M	DX02-621-951J
	4-way, 2-position, air return	0.55	Single solenoid	Internal	Non-locking	DX02-651-951M	DX02-651-951J
	4-way, 2-position	0.55	Double solenoid	Internal	Non-locking	DX02-606-951M	DX02-606-951J
	4-way, 3-position, center exhaust	0.4	Double solenoid	Internal	Non-locking	DX02-611-951M	DX02-611-951J
	4-way, 3-position, all ports blocked	0.4	Double solenoid	Internal	Non-locking	DX02-616-951M	DX02-616-951J

Symbol	Type	Cv	Operator	Pilot	Part number
	4-way, 2-position, spring return	0.55	Single remote pilot	Remote	DX02-421-60
	4-way, 2-position, air return	0.55	Single remote pilot	Remote	DX02-451-60
	4-way, 2-position	0.55	Double remote pilot	Remote	DX02-406-60
	4-way, 3-position, center exhaust	0.4	Double remote pilot	Remote	DX02-411-60
	4-way, 3-position, all ports blocked	0.4	Double remote pilot	Remote	DX02-416-60

DX02 Series Subbase & Manifolds

Single subbase	1/8" NPT	1/8" BSPP
 Side ported base	PL02-01-80	PL02-01-70
2 Station manifold bases		
 End ported bases	1/8" NPT	1/8" BSPP
	PJLP02-201-80	PJLP02-201-70
End plate kit	1/8" NPT port	1/8" BSPP port
 End plate kit	PEJ02-02-80	PEJ02-02-70

Add-A-Fold Assembly Model Number

AA 02U 0 04

Valve series	Number of stations*
Right & left end plate DX02	02U*
	02
	04
	•
	24
	•
	32

* For use with PJLP02 Manifolds.





Thread type	
NPT	0
BSPP "G"	1



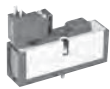

* Must be ordered in multiples of (2)

DX02 Series Accessories



Accessory	Description	Part number
Sandwich regulator 	Common pressure	2-60 PSIG w/ gauge PS5637155P
	Common pressure	5-125 PSIG w/ gauge PS5637166P
	Independent pressure	2-60 PSIG w/ gauge PS5637255P
	Independent pressure	5-125 PSIG w/ gauge PS5637266P
Gauge adapter kit	Includes 1/8" coupling and long nipple	PS5651160P
Blanking plate kit		PS5634P
Sandwich supply module	1/8" NPT	PS562600P
	1/8" BSPP	PS562601P
Sandwich exhaust module	1/8" NPT	PS562700P
	1/8" BSPP	PS562701P
Intermediate air supply module	1/8" NPT	D02P-01-80
Sandwich flow control		PS5642P
Manifold to manifold gasket kits	Used with manifold PJLP02	DX02M2MGSKT
Manifold port isolation kits (main galley 1, 3, & 5)	For use on PJLP and PJJ series manifolds. Kit includes: plugs with o-rings.	D02BD0
Manifold hardware kit	Includes 10 bolts, 10 washers, 10 nuts	DX02M2MB

DX01 ISO Valves

Symbol	Type	Cv	Operator	Pilot	Override	24 VDC	120 VAC
	Sol. 14 4-way, 2-position, spring return	0.75	Single solenoid	Internal	Non-locking	DX01-621-951M	DX01-621-951J
	Sol. 14 4-way, 2-position, air return	0.75	Single solenoid	Internal	Non-locking	DX01-651-951M	DX01-651-951J
	Sol. 14 4-way, 2-position	0.75	Double solenoid	Internal	Non-locking	DX01-606-951M	DX01-606-951J
	Sol. 14 4-way, 3-position, center exhaust	0.5	Double solenoid	Internal	Non-locking	DX01-611-951M	DX01-611-951J
	Sol. 14 4-way, 3-position, all ports blocked	0.5	Double solenoid	Internal	Non-locking	DX01-616-951M	DX01-616-951J

Symbol	Type	Cv	Operator	Pilot	Part number
	Sol. 14 4-way, 2-position, spring return	0.75	Single remote pilot	Remote	DX01-421-60
	Sol. 14 4-way, 2-position, air return	0.75	Single remote pilot	Remote	DX01-451-60
	Sol. 14 4-way, 2-position	0.75	Double remote pilot	Remote	DX01-406-60
	Sol. 14 4-way, 3-position, center exhaust	0.5	Double remote pilot	Remote	DX01-411-60
	Sol. 14 4-way, 3-position, all ports blocked	0.5	Double remote pilot	Remote	DX01-416-60

DX01 Series Subbase & Manifolds

Single subbase	1/4" NPT	1/4" BSPP
 Side ported base	PL01-02-80	PL01-02-70
2 Station manifold bases	1/4" NPT	1/4" BSPP
 End ported bases	PJLP01-202-80	PJLP01-202-70
End plate kit	1/4" NPT port	1/4" BSPP port
 End plate kit	PEJ01-03-80	PEJ01-03-70

Add-A-Fold Assembly Model Number

AA 01U 0 04

Valve series	Number of stations*
Right & left end plate DX01	02
	04
	•
	24
	•
	32

* For use with PJLP01 or PJL01 Manifolds.

Thread type	
NPT	0
BSPP "G"	1

* Must be ordered in multiples of (2)

DX01 Series Accessories

Accessory	Description	Part number
Sandwich regulator 	Common pressure	2-60 PSIG w/ gauge PS5537155P
	Common pressure	5-125 PSIG w/ gauge PS5537166P
	Independent pressure	2-60 PSIG w/ gauge PS5537255P
	Independent pressure	5-125 PSIG w/ gauge PS5537266P
Gauge adapter kit	Includes 1/8" coupling and long nipple	PS5651160P
Remote pilot access plate kit	1/4" NPT	PS551500P
	1/4" BSPP	PS551501P
Blanking plate kit		PS5534P
Sandwich supply module	1/4" NPT	PS552600P
	1/4" BSPP	PS552601P
Sandwich exhaust module	1/4" NPT	PS552700P
	1/4" BSPP	PS552701P
Intermediate air supply module	1/4" NPT	D01P-02-80
Sandwich flow control		PS5542P
Manifold to manifold gasket kits	Used with manifold PJLP02	DX01M2MGSKT
Manifold port isolation kits (main galley 1, 3, & 5)	For use on PJLP and PJL series manifolds. Kit includes: plugs with o-rings.	D01BD0
Manifold hardware kit	Includes 10 bolts, 10 washers, 10 nuts	DX02M2MB

Modulflex Series

Isys Micro Series

Isys ISO Series

Fieldbus





DX ISOMAX Series



Valvair II Series

D



Subbase & Manifold Valve Products

DX1 ISO Valves

Symbol	Type	Cv	Operator	Pilot	Override	24 VDC	120 VAC
 Sol. 14	4-way, 2-position, spring return	1.15	Single solenoid	Internal	Non-locking	DX1-621-BL49	DX1-621-BL53
					Locking	DX1-621-CL49	DX1-621-CL53
 Sol. 14	4-way, 2-position, air return	1.15	Single solenoid	Internal	Non-locking	DX1-651-BL49	DX1-651-BL53
					Locking	DX1-651-CL49	DX1-651-CL53
 Sol. 14	4-way, 2-position	1.15	Double solenoid	Internal	Non-locking	DX1-606-BL49	DX1-606-BL53
					Locking	DX1-606-CL49	DX1-606-CL53
 #14	4-way, 3-position, center exhaust	0.75	Double solenoid	Internal	Non-locking	DX1-611-BL49	DX1-611-BL53
					Locking	DX1-611-CL49	DX1-611-CL53
 #14	4-way, 3-position, all ports blocked	0.75	Double solenoid	Internal	Non-locking	DX1-616-BL49	DX1-616-BL53
					Locking	DX1-616-CL49	DX1-616-CL53

Symbol	Type	Cv	Operator	Pilot	Part number
 #14	4-way, 2-position, spring return	1.15	Single remote pilot	Remote	DX1-421-60
					4-way, 2-position, air return
 #14	4-way, 2-position	1.15	Double remote pilot	Remote	DX1-406-60
					4-way, 3-position, center exhaust
 #14	4-way, 3-position, all ports blocked	0.75	Double remote pilot	Remote	DX1-416-60

DX1 Series Subbase & Manifolds

Single subbase	Description	3/8" NPT	3/8" BSPP
	Side ported base	PS4011150CP	PS4011160CP
	Manifold bases	3/8" NPT	3/8" BSPP
	End ported bases	PS4011550CP	PS4011560CP
	Bottom / End ported bases	PS4011650CP	PS4011660CP
End plate kits		NPT port	BSPP port
	DX1 non-collective wiring end plates	PS4031010CP	PS4031011CP

5599-1, DX1 Accessories

Accessories	Description	Part number
Sandwich regulator 	Common pressure	5-125 PSIG w/ gauge PS4037166CP
	Independent pressure	5-125 PSIG w/ gauge PS4037266CP
Remote pilot access plate kit	1/8" NPT 1/8" BSPP	PS401500CP PS401501CP
Blanking plate kit		PS4034CP
Sandwich flow control		PS4042CP
Manifold to manifold gasket kit		PS4013P
Manifold port isolation kits	Main galley (1, 3, 5)	PS4032CP
Manifold port isolation kits	Pilot galley	PS4033CP
Auxiliary access plate kit	1/4" & 3/8"	NPT PS403000CP
		BSPP PS403001CP

How To Order Add-A-Fold Assemblies

- List Add-A-Fold Assembly call out. This automatically includes the end plate kit assembly.
 - List complete valve/base model number. List left to right, looking at the cylinder ports on the #12 end of the manifold. The left most station is station 1.
- (If a blank station is needed, list the blanking plate part number and the individual manifold number in the station specified.)

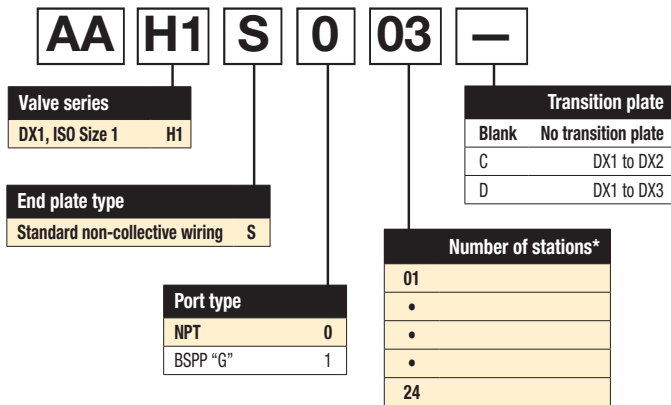

Example: Application requires a 3-Station manifold.

Qty.	Part No.
1	AAH1S003
1	DX1-621-BL49..... Valve Station 1
1	PS4011550CP.....Base Station 1
1	DX1-616-BL49 Valve Station 2
1	PS4011550CP.....Base Station 2
1	DX1-611-BL49 Valve Station 3
1	PS4011550CP.....Base Station 3



Modulflex Series

Isys Micro Series

Isys ISO Series

Fieldbus

DX ISOMAX Series

Valvair II Series

D

Subbase & Manifold Valve Products

DX2 ISO Valves

Symbol	Type	Cv	Operator	Pilot	Override	24 VDC	120 VAC
	4-way, 2-position, spring return	2.5	Single solenoid	Internal	Non-locking	DX2-621-BL49	DX2-621-BL53
					Locking	DX2-621-CL49	DX2-621-CL53
	4-way, 2-position, air return	2.5	Single solenoid	Internal	Non-locking	DX2-651-BL49	DX2-651-BL53
					Locking	DX2-651-CL49	DX2-651-CL53
	4-way, 2-position	2.5	Double solenoid	Internal	Non-locking	DX2-606-BL49	DX2-606-BL53
					Locking	DX2-606-CL49	DX2-606-CL53
	4-way, 3-position, center exhaust	2.4	Double solenoid	Internal	Non-locking	DX2-611-BL49	DX2-611-BL53
					Locking	DX2-611-CL49	DX2-611-CL53
	4-way, 3-position, all ports blocked	2.4	Double solenoid	Internal	Non-locking	DX2-616-BL49	DX2-616-BL53
					Locking	DX2-616-CL49	DX2-616-CL53
Symbol	Type	Cv	Operator	Pilot	Part number		
	4-way, 2-position, spring return	2.5	Single remote pilot	Remote	DX2-421-60		
						2.5	Single remote pilot
	4-way, 2-position	2.5	Double remote pilot	Remote			
						4-way, 3-position, center exhaust	2.4
	4-way, 3-position, all ports blocked	2.4	Double remote pilot	Remote			

DX2 Series Subbase & Manifolds

Single subbase	Description	1/2" NPT	1/2" BSPP
	Side ported base	PS4111170CP	PS4111180CP

Manifold bases	Description	1/2" NPT	1/2" BSPP
	Bottom / End ported bases Note: Manifolds include 2 pipe plugs	PS4111670CP	PS4111680CP

End plate kits	Description	NPT port	BSPP port
	H2 Non-collective wiring end plates	PS4131010CP	PS4131011CP

5599-1, DX2 Accessories

Accessories	Description	Part number
	Common pressure 5-125 PSIG w/ gauge	PS4137166CP
	Independent pressure 5-125 PSIG w/ gauge	PS4137266CP
Remote pilot access plate kit	1/8" NPT	PS411500CP
	1/8" BSPP	PS411501CP
Blanking plate kit		PS4134CP
Sandwich flow control		PS4142CP
Manifold to manifold gasket kit		PS4113P
Manifold port isolation kits	Main galley (1, 3, 5)	PS4132CP
Manifold port isolation kits	Pilot galley	PS4033CP

How To Order Add-A-Fold Assemblies



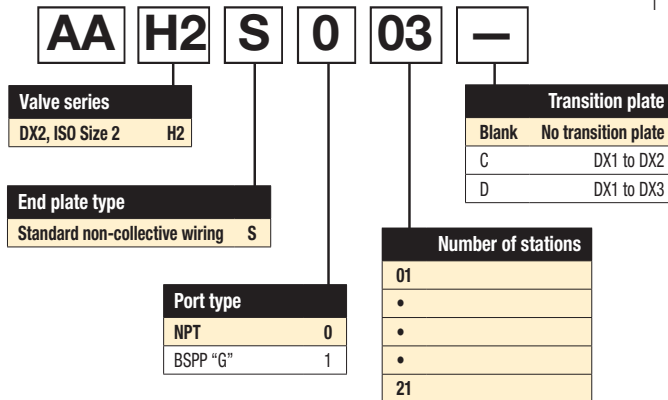

- List Add-A-Fold Assembly call out. This automatically includes the end plate kit assembly.
- List complete valve/base model number. List left to right, looking at the cylinder ports on the #12 end of the manifold. The left most station is station 1.
(If a blank station is needed, list the blanking plate part number and the individual manifold number in the station specified.)

Example: Application requires a 3-station manifold.

Qty.	Part No.
1	AAH2S003
1	DX2-621-BL49..... Valve Station 1
1	PS4111570CP.....Base Station 1
1	DX2-616-BL49 Valve Station 2
1	PS4111570CP.....Base Station 2
1	DX2-611-BL49 Valve Station 3
1	PS4111570CP.....Base Station 3

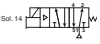

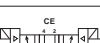

DX3 ISO Valves

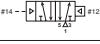
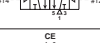
Symbol	Type	Cv	Operator	Pilot	Override	24 VDC	120 VAC
	4-way, 2-position, spring return	4.15	Single solenoid	Internal	Non-locking	DX3-621-BL49	DX3-621-BL53
					Locking	DX3-621-CL49	DX3-621-CL53
	4-way, 2-position, air return	4.15	Single solenoid	Internal	Non-locking	DX3-651-BL49	DX3-651-BL53
					Locking	DX3-651-CL49	DX3-651-CL53
	4-way, 2-position	4.15	Double solenoid	Internal	Non-locking	DX3-606-BL49	DX3-606-BL53
					Locking	DX3-606-CL49	DX3-606-CL53
	4-way, 3-position, center exhaust	4.0	Double solenoid	Internal	Non-locking	DX3-611-BL49	DX3-611-BL53
					Locking	DX3-611-CL49	DX3-611-CL53
	4-way, 3-position, all ports blocked	4.0	Double solenoid	Internal	Non-locking	DX3-616-BL49	DX3-616-BL53
					Locking	DX3-616-CL49	DX3-616-CL53

Symbol	Type	Cv	Operator	Pilot	Part number
	4-way, 2-position, spring return	4.15	Single remote pilot	Remote	DX3-421-60
				Remote	DX3-451-60
	4-way, 2-position, air return	4.15	Single remote pilot	Remote	DX3-406-60
				Remote	DX3-411-60
	4-way, 3-position, center exhaust	4.0	Double remote pilot	Remote	DX3-416-60
				Remote	DX3-416-60

DX3 Series Subbase & Manifolds

	Single subbase	Description	3/4" NPT	3/4" BSPP
		Side ported base	PS4211170CP	PS4211180CP
	Manifold bases	Description	3/4" NPT	3/4" BSPP
		Bottom / End ported bases Note: Manifolds include 2 pipe plugs	PS4211690CP	PS4211600CP
	End plate kits	Description	NPT port	BSPP port
		H3 Non-collective wiring end plates	PS4231010CP	PS4231011CP

5599-1, DX3 Accessories

Accessories	Description	Part number
Sandwich regulator 	Common pressure 5-125 PSIG w/ gauge	PS4237166CP
	Independent pressure 5-125 PSIG w/ gauge	PS4237266CP
Remote pilot access plate kit	1/8" NPT	PS421500CP
	1/8" BSPP	PS421501CP
Blanking plate kit		PS4134CP
Sandwich flow control		PS4242CP
Manifold to manifold gasket kit		PS4213P
Manifold port isolation kits	Main galley (1, 3, 5)	PS4232CP
Manifold port isolation kits	Pilot galley	PS4033CP

Modultex Series
 Isys Micro Series
 Isys ISO Series
 Fieldbus
 DX ISOMAX Series
 Valvair II Series
D
 Subbase & Manifold Valve Products

How To Order Add-A-Fold Assemblies

1. List Add-A-Fold Assembly call out. This automatically includes the end plate kit assembly.
2. List complete valve/base model number. List left to right, looking at the cylinder ports on the #12 end of the manifold. The left most station is station 1.
 (If a blank station is needed, list the blanking plate part number and the individual manifold number in the station specified.)

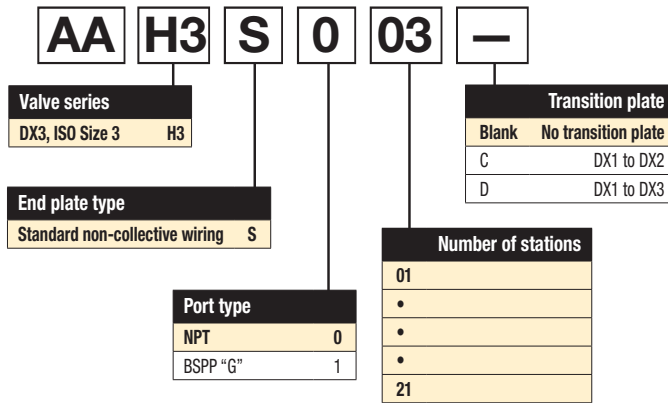

Example: Application requires a 3-station manifold.

Qty.	Part No.
1	AAH3S003
1	DX3-621-BL49..... Valve Station 1
1	PS4111590CP.....Base Station 1
1	DX3-616-BL49 Valve Station 2
1	PS4111590CP.....Base Station 2
1	DX3-611-BL49 Valve Station 3
1	PS4111590CP.....Base Station 3

Modulflex Series
 Isys Micro Series
 Isys ISO Series
 Fieldbus
 DX ISOMAX Series
 Valvair-II Series
D
 Subbase & Manifold Valve Products

15mm 3-Pin DIN 43650C Replacement Solenoid Kits

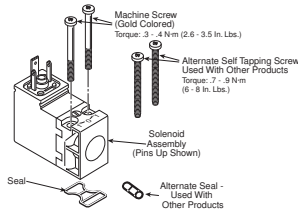

Voltage	Non-locking	Locking
24VDC	PS2982B49P	PS2982C49P
110/50, 120/60	PS2982B53P	PS2982C53P

15mm 3-Pin DIN 43650C Connectors

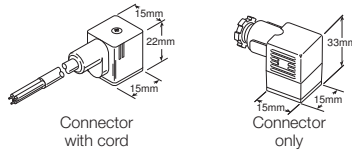

Description	Connector with 6' (2m) Cord	Connector
No circuit board	PS2932JBP	PS2932BP
Light – 24DC	PS2946J79BP*	PS294679BP
Light – 110/120VAC	PS2946J83BP*	PS294683BP

* LED with surge suppression.

Note: Max. ø6.5mm cable size required for connector without 6' (2m) cord. IP65 rated when properly installed.

Engineering Data:

Conductors: 2 poles plus ground
 Cable range (Connector only): 4 to 6mm (0.16 to 0.24 Inch)
 Contact spacing: 8mm

Female Electrical Connectors (IP65 Rated) 30mm, 3-Pin ISO 4400, (DIN 43650A)

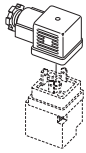

Description	Connector with 6' (2m) cord	Connector
Unlighted	PS2028JCP	PS2028BP
Light – 6-48V, 50/60Hz; 6-48VDC	PS2032J79CP*	PS203279BP
Light – 120V/60Hz	PS2032J83CP*	PS203283BP
Light – 240V/60Hz	N/A	PS203283BP

* With surge suppression.

Engineering data:

Conductors: 2 poles plus ground; cable range (connector only): 8 to 10mm (0.31 To 0.39 inch); Contact spacing: 18mm

5599-1 CNOMO Solenoid Kits

Voltage code	3-pin, 30mm 'L' coil kit	2-pin, M12 Euro '6' coil kit
19	—	PS2828619P
42	P2FCA442	—
45	P2FCA445	—
49	P2FCA449	—
53	P2FCA453	—
57	P2FCA457	—

Quantity 1

Pilot Operator - CNOMO

Valve size	Kit number
DX1, DX2 & DX3	Locking PS4052CP
	Non-locking PS4053CP

CNOMO Operator Adapter

Description	Kit number
Operator adapter	PS2855P

Manifold to Manifold Gasket Kits

Size	Part number
DX02*	DX02M2MGSKT (PJLP02)
DX01*	DX01M2MGSKT (PJLP01)

* Gaskets used with PS5611 & PS5511 manifolds.

Modulflex Series
 Isys Micro Series
 Isys ISO Series
 Fieldbus
 DX ISOMAX Series
 Valvair II Series
D
 Subbase & Manifold Valve Products

DX01 & DX02 Valve Dimensions

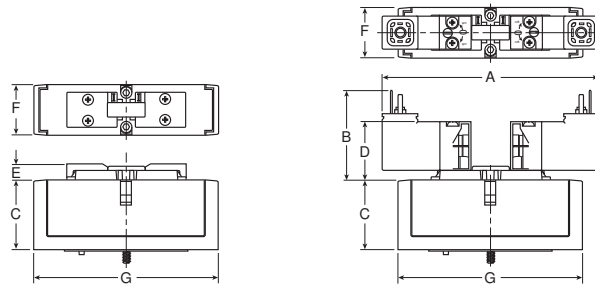

Series	A	B	C	D	E	F	G
DX02	4.06 (103)	1.61 (41)	1.41 (36)	1.06 (27)	.31 (8)	.71 (18)	3.15 (80)
DX01	4.06 (103)	1.61 (41)	1.41 (36)	1.06 (27)	.31 (8)	1.02 (26)	3.94 (100)

Inches (mm)

DX01 & DX02 Individual Subbase Dimensions

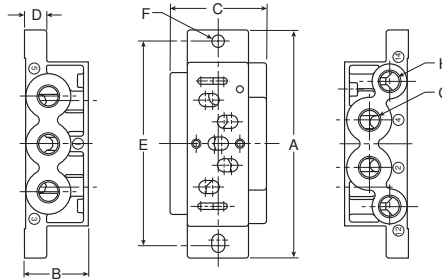

Series	Part number	A	B	C	D	E	F	G	H
DX02	PL02	3.15 (80)	.87 (22)	1.06 (27)	.31 (8)	2.76 (70)	.216 Dia. (Ø 5.5)	1/8	M5
DX01	PL01	3.94 (100)	1.10 (28)	1.65 (42)	.39 (10)	3.54 (90)	.216 Dia. (Ø 5.5)	1/4	1/8

Inches (mm)

DX01 & DX02 2-Station Manifold Base Dimensions

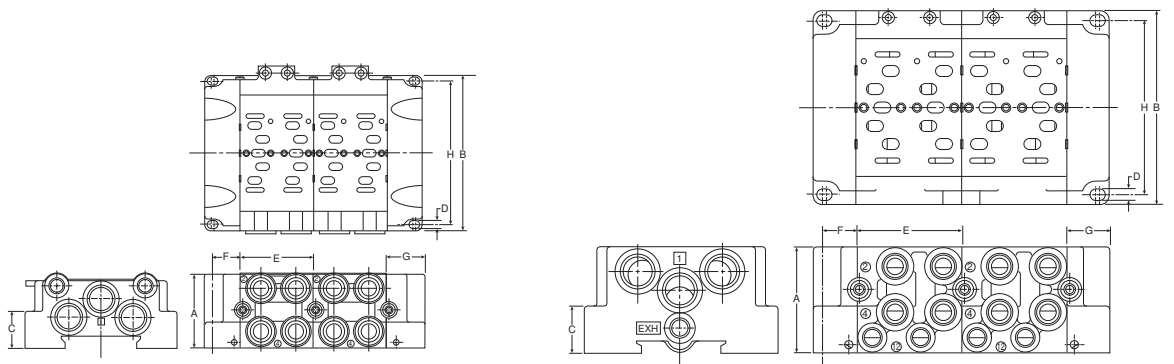

Series	Part number	A	B	C	D	E	F	G	H
DX02	PJLP02 / PEJ02	1.52 (38.5)	3.15 (80)	.47 (12)	.165 Dia. (Ø 4.2)	1.50 (38)	.55 (14)	.71 (18)	2.83 (72)
DX01	PJL01 / PJLP01 / PEJ01	2.17 (55)	3.94 (100)	.94 (24)	.216 Dia. (Ø 5.5)	2.13 (54)	.67 (17)	.87 (22)	3.54 (90)

Inches (mm)

Modulflex Series
 Isys Micro Series
 Isys ISO Series
 Fieldbus
DX ISOMAX Series
 Valvair-II Series
D
 Subbase & Manifold Valve Products

DX1, DX2 & DX3 Air Operated Valve Dimensions

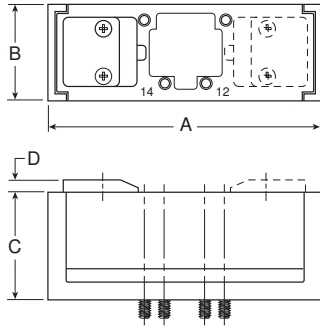

Series	A	B	C	D
DX1	4.72 (120)	1.65 (42)	1.85 (47)	.20 (5)
DX2	5.51 (140)	2.13 (54)	2.30 (58.5)	.20 (5)
DX3	6.69 (170)	2.68 (68)	2.80 (71)	.20 (5)

Inches (mm)

Modulflex
Series

Isys Micro
Series

Isys ISO
Series

DX1, DX2 & DX3 Solenoid Operated Valve Dimensions

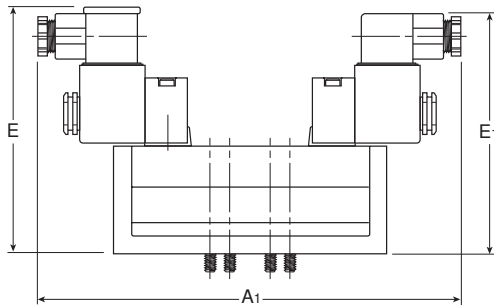

Series	A ₁	E	E ₁	E ₂
DX1	7.97 (202.5)	4.43 (112.5)	4.69 (119)	4.53 (115)
DX2	8.58 (218)	4.86 (123.5)	5.12 (130)	4.98 (126.5)
DX3	9.27 (235.5)	5.35 (136)	5.61 (142.5)	5.47 (139)

Inches (mm)

Fieldbus

DX ISOMAX
Series

Valvair II
Series

D

Subbase & Manifold
Valve Products

DX1 Subbase Dimensions

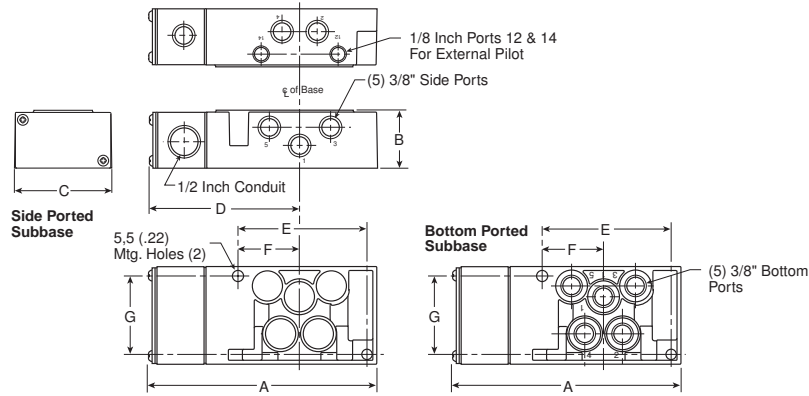

PS4011 Subbase

A	B	C	D
5.83 (148)	1.48 (38)	2.50 (64)	3.86 (98)
E	F	G	
3.29 (84)	1.57 (40)	2.00 (51)	

Inches (mm)

DX2 Subbase Dimensions

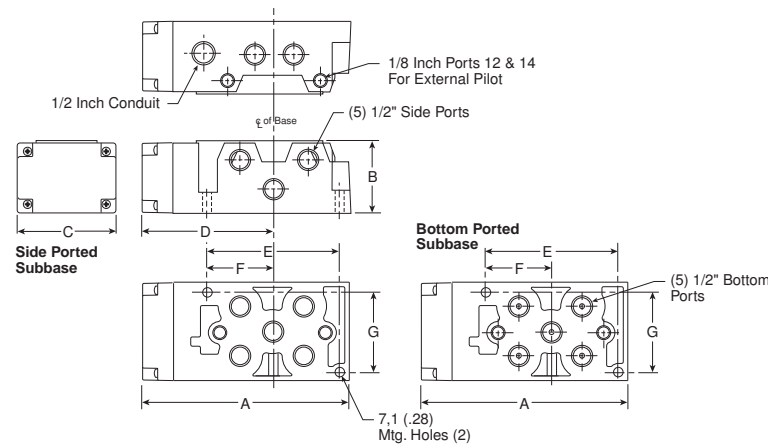

PS4111 Subbase

A	B	C	D
6.69 (170)	2.33 (59)	3.15 (80)	4.25 (108)
E	F	G	
4.21 (107)	2.07 (52)	2.56 (65)	

Inches (mm)

DX3 Subbase Dimensions

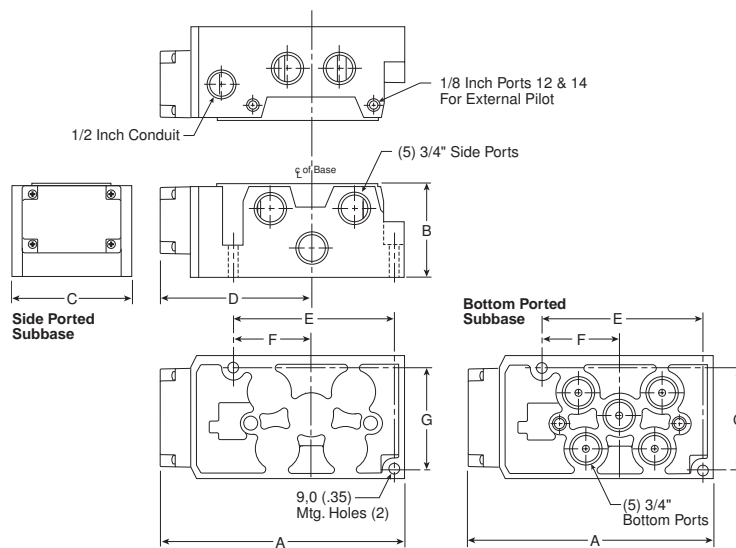

PS4211 Subbase

A	B	C	D
7.90 (201)	2.96 (75)	3.90 (990)	4.92 (125)
E	F	G	
5.14 (131)	2.50 (64)	3.24 (82)	

Inches (mm)

Modulflex Series
Isys Micro Series
Isys ISO Series
Fieldbus
DX ISOMAX Series
Valvair II Series
D Subbase & Manifold Valve Products

DX1 Manifold Dimensions

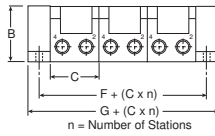
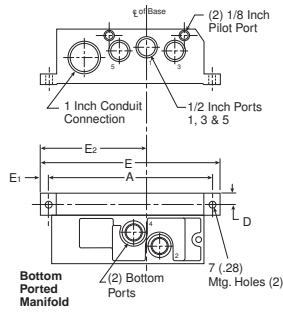

PS4011 Manifold

A	B	C	D	E
6.50 (165)	2.20 (56)	1.93 (49)	.44 (11)	7.15 (182)
E1	E2	F	G	
.33 (8)	4.25 (108)	.87 (22)	1.80 (46)	

Inches (mm)

Modulflex Series
 Isys Micro Series
 Isys ISO Series

DX2 Manifold Dimensions

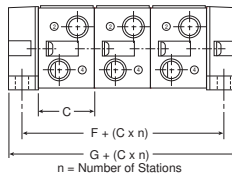
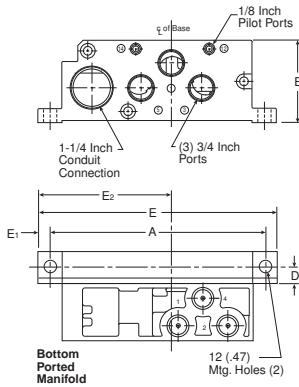

PS4111 Manifold

A	B	C	D	E
8.46 (215)	3.35 (85)	2.20 (56)	.59 (15)	9.41 (239)
E1	E2	F	G	
.47 (12)	5.28 (134)	1.18 (30)	2.36 (60)	

Inches (mm)

Fieldbus Series
 DX ISOMAX Series

DX3 Manifold Dimensions

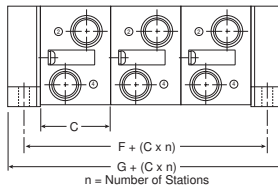
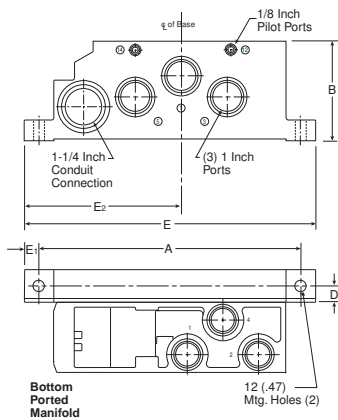

PS4211 Manifold

A	B	C	D	E
10.41 (265)	4.13 (105)	2.80 (71)	.65 (175)	11.61 (295)
E1	E2	F	G	
.59 (15)	6.26 (159)	1.30 (33)	2.60 (63)	

Inches (mm)

Valvair II Series
D
 Subbase & Manifold Valve Products